

8	7	6	5	4	3	2	1
NO.		ECN NO.		DESCRIPTION		REV.	DATE

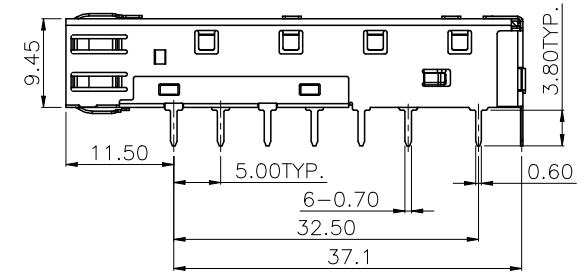
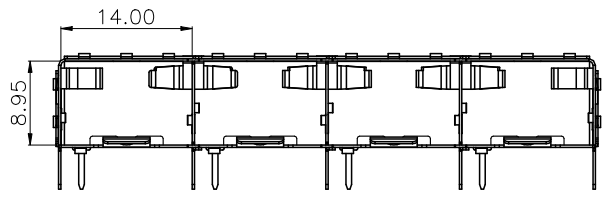
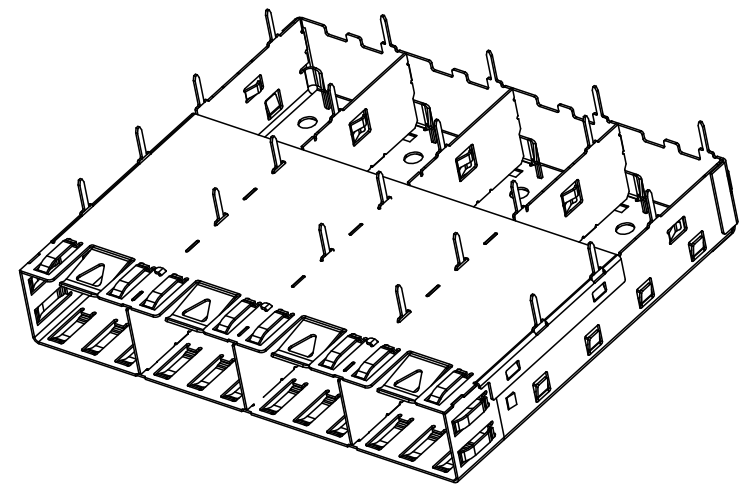
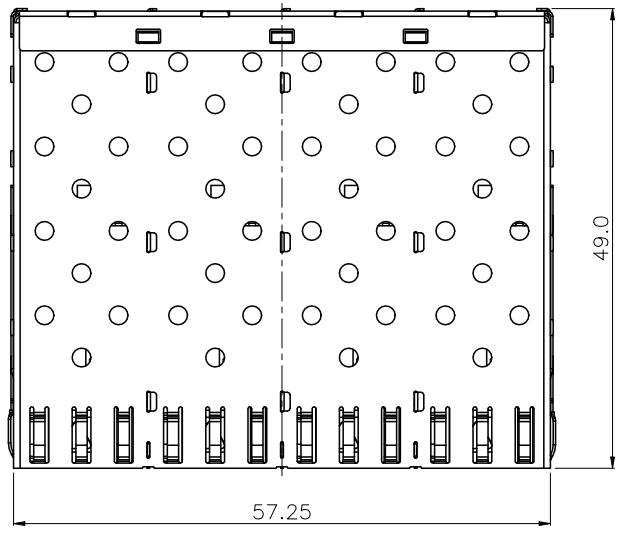

NOTES:
1.MATERIAL:COPPER ALLOY THICKNESS:0.25mm.

产品客户图 Customer Drw	
未注公差	.X ±0.35
TOLERANCE	.XX ±0.25
UNLESS	.XXX ±0.15
OTHERWISE	X° ±2°
SPECIFIED	
比例	1:1
SCALE	角法
	PROJ.
张数	大小
SHEET	SIZE
单位	版本
UNIT	REV.

GLGNET® 深圳市方向电子股份有限公司
SHEN ZHEN GLGNET ELECTRONICS CO.,LTD.

设计	品名	1x4 SFP-D 焊接式
DESIGN	TITLE	
校对	料号	46023-00A011
CHECKED	ITEM NO.	
核准	图号	GLG-WS-114
APPROVED	DWG NO.	

8	7	6	5	4	3	2	1			
					NO.	ECN NO.	DESCRIPTION	REV.	DRAW	DATE

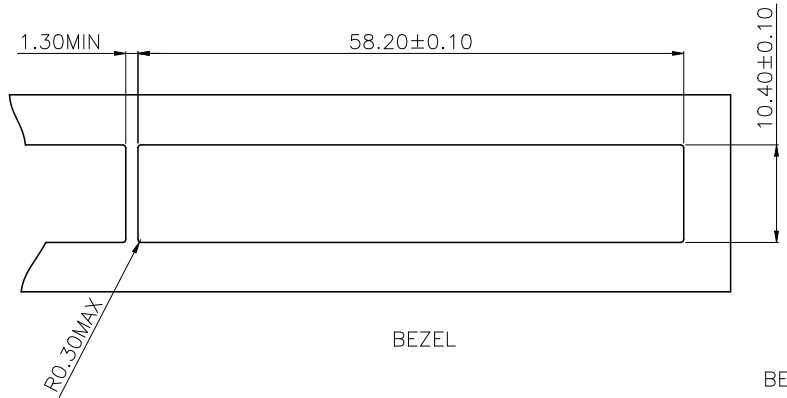

BEZEL

BEZEL OPENING
BELOW TOP OF PCB

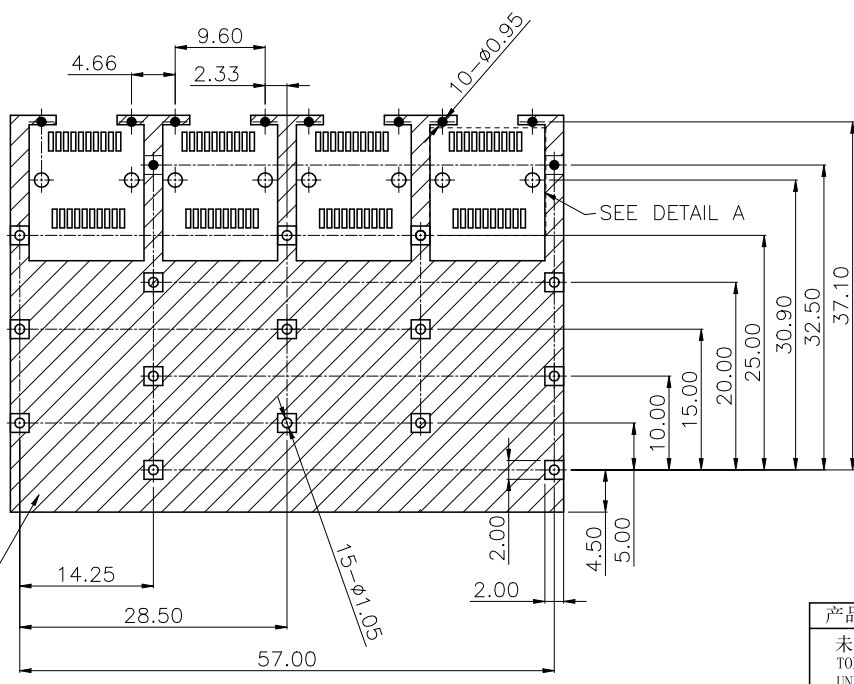
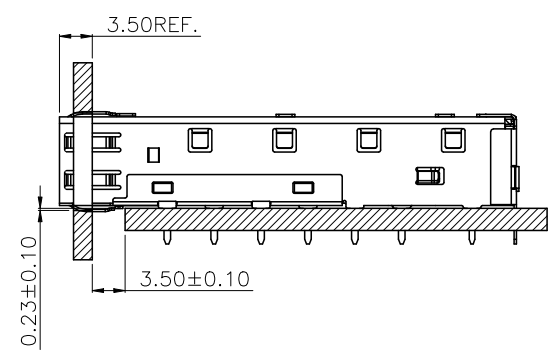

CROSS-HATCHED AREA DENOTES
COMPONENT AND TRACE KEEP-OUT

EDGE OF BOARD
RECOMMENDED PCB LAOUT (COMPONENT SIDE)
PCB TOLERANCE:±0.05

"□ ● ●"圆孔均为通孔

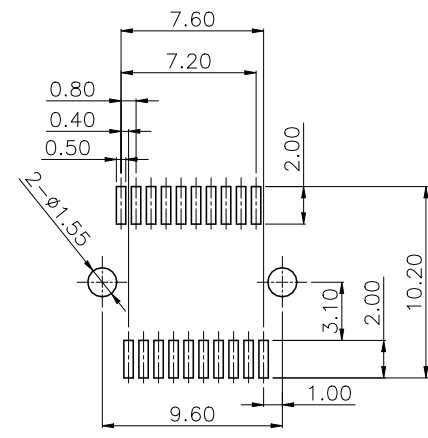

DETAIL A(SCALE 2:1)

产品客户图	Customer Drw	
未注公差	.X	±0.35
TOLERANCE	.XX	±0.25
UNLESS	.XXX	±0.15
OTHERWISE	X°	±2°
SPECIFIED		

GLGNET® 深圳市方向电子股份有限公司
SHEN ZHEN GLGNET ELECTRONICS CO.,LTD.

比例 SCALE	1:1	角法 PROJ.	设计 DESIGN	品名 TITLE	1x4 SFP-D 焊接式
张数 SHEET	2/2	大小 SIZE	A4	料号 ITEM NO.	46023-00A011
单位 UNIT	mm	版本 REV.	A0	图号 DWG NO.	GLG-WS-114