

NO.	ECN NO.	DESCRIPTION	REV.	DRAW	DATE
1					
2					
3					

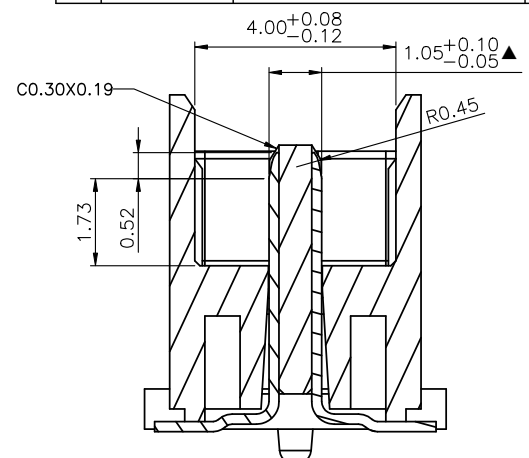

喷字 (是否喷码见客户包规):
DATE CODE:YYWW

YY=年(两位, 如2020年就取数字20)
WW=1年中的第几周(两位)
D=1周中的星期几(一位)

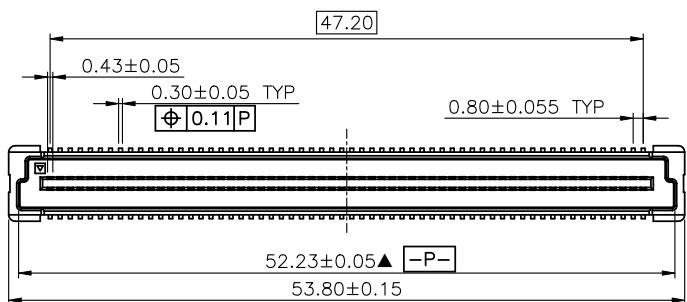
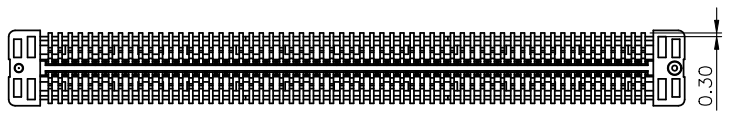
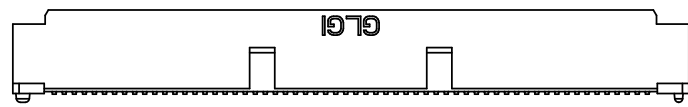
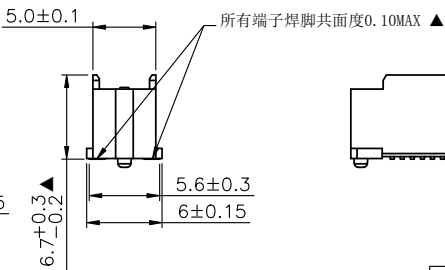
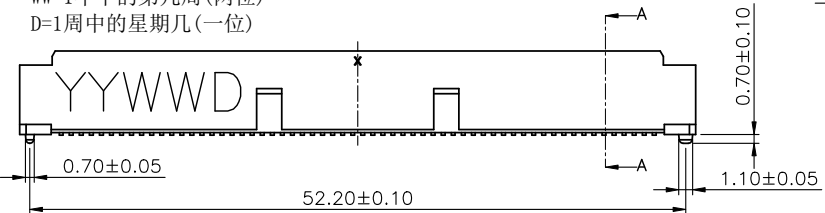

16001-01XXX1
成品识别码
M17: Ni50-100u", Au8u", Sn80-120u"
M19: Ni50-100u", Au15u", Sn80-120u"
M23: Ni50-100u", Au30u", Sn80-120u"
规格流水码

- NOTES:
1. HOUSING: LCP UL94V-0, NATURAL.
2. CONTACT: COPPER ALLOY.
3. PICK UP: STAINLESS STEEL.
4. THE HOUSING WITH WITHSTAND EXPOSURE UP TO 260° PEAK TEMPERATURE FOR 30 SECONDS IN A CONVECTION, INFRA-RED OR VAPOR REFLOW OVEN.
5. ▲DENOTES CRITICAL DIMENSION.

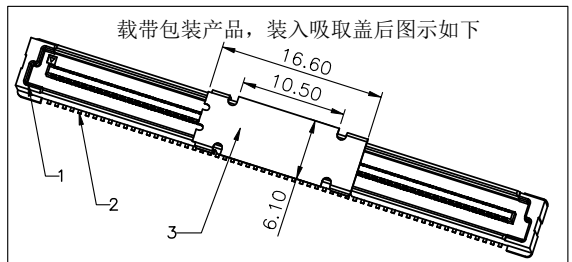

未注公差 TOLERANCE UNLESS OTHERWISE SPECIFIED	.X	±0.20
	.XX	±0.15
	.XXX	±0.08
	X°	±3°

GLGNET® 深圳市方向电子股份有限公司
SHEN ZHEN GLGNET ELECTRONICS CO., LTD.

比例 SCALE	1:1	角法 PROJ.	第一角法	设计 DESIGN		品名 TITLE	BTB M-SV-1-2x60-P080-H67-01
张数 SHEET	1/2	大小 SIZE	A4	校对 CHECKED		料号 ITEM NO.	16001-01XXX1
单位 UNIT	mm	版本 REV.	A2	核准 APPROVED		图号 DWG NO.	GLG-WS-549

NO.	ECN NO.	DESCRIPTION	REV.	DRAW	DATE
1					
2					
3					

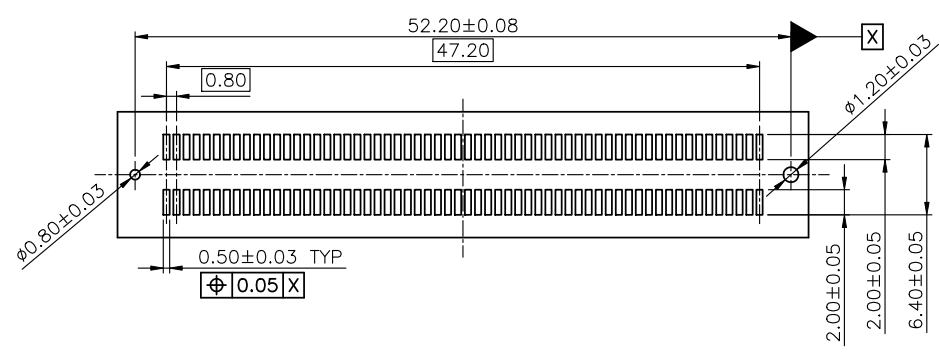

RECOMMENDED PCB LAYOUT

RECOMMENDED METAL MASK THICKNESS:0.05mm

产品客户图 Customer Drw		GLGNET® 深圳市方向电子股份有限公司 SHEN ZHEN GLGNET ELECTRONICS CO., LTD.	
未注公差 TOLERANCE	.X ±0.20	设计 DESIGN	品名 TITLE BTB M-SV-1-2x60-P080-H67-01
UNLESS OTHERWISE SPECIFIED	.XX ±0.15		
	.XXX ±0.08		
	X° ±3°		
比例 SCALE	1:1	角法 PROJ.	料号 ITEM NO.
张数 SHEET	2/2	大小 SIZE	16001-01XXX1
单位 UNIT	mm	版本 REV.	图号 DWG NO.
		A2	GLG-WS-549