

NO.	ECN NO.	DESCRIPTION	REV.	DRAW	DATE
1					
2					
3					

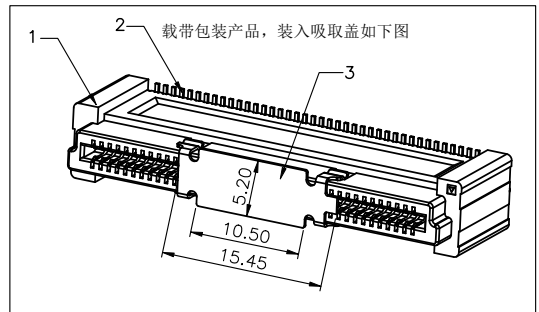

喷字 (是否喷码见客户包规):
 DATE CODE: YYWW
 YY=年(两位, 如2020年就取数字20)
 WW=1年中的第几周(两位)
 D=1周中的星期几(一位)

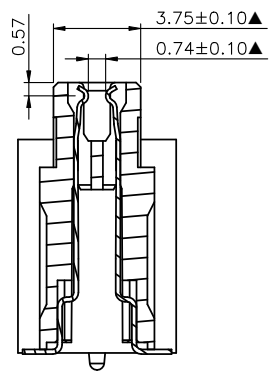
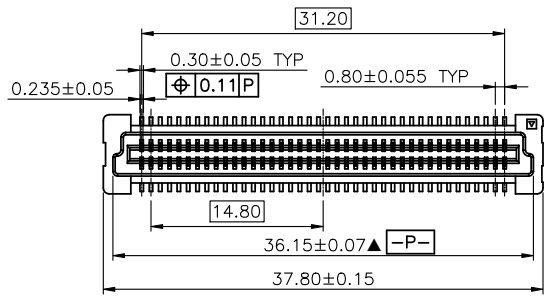
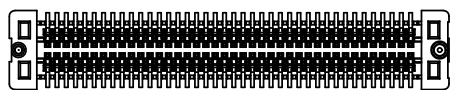
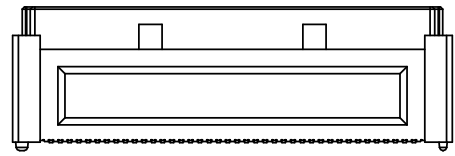
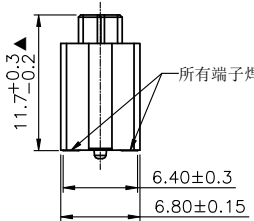
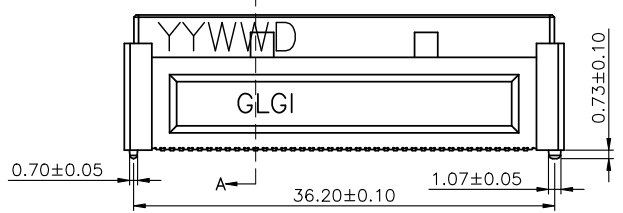

16007-00XXX1
 成品识别码
 M17: Ni50-100u", Au8u", Brume Sn80-120u"
 M19: Ni50-100u", Au15u", Brume Sn80-120u"
 M23: Ni50-100u", Au30u", Brume Sn80-120u"
 规格流水码

NOTES:
 1. HOUSING: LCP UL94V-0, NATURAL.
 2. CONTACT: COPPER ALLOY.
 3. PICK UP: STAINLESS STEEL.
 4. THE HOUSING WITH WITHSTAND EXPOSURE UP TO 260° PEAK TEMPERATURE FOR 30 SECONDS IN A CONVECTION, INFRA-RED OR VAPOR REFLOW OVEN.
 5. ▲DENOTES CRITICAL DIMENSION.

产品客户图 Customer Drw		设计 DESIGN		品名 TITLE	
未注公差 TOLERANCE	.X ±0.20	角法 PROJ.	设计	品名	BTB F-SV-1-2x40-P080-H117-00
UNLESS OTHERWISE SPECIFIED	.XX ±0.15	大小 SIZE	校对 CHECKED	料号 ITEM NO.	16007-00XXX1
	.XXX ±0.08	版本 REV.	核准 APPROVED	图号 DWG NO.	GLG-WS-551
	X° ±3°	单位 UNIT			

GLGNET® 深圳市方向电子股份有限公司
 SHEN ZHEN GLGNET ELECTRONICS CO., LTD.

NO.	ECN NO.	DESCRIPTION	REV.	DRAW	DATE
1					
2					
3					

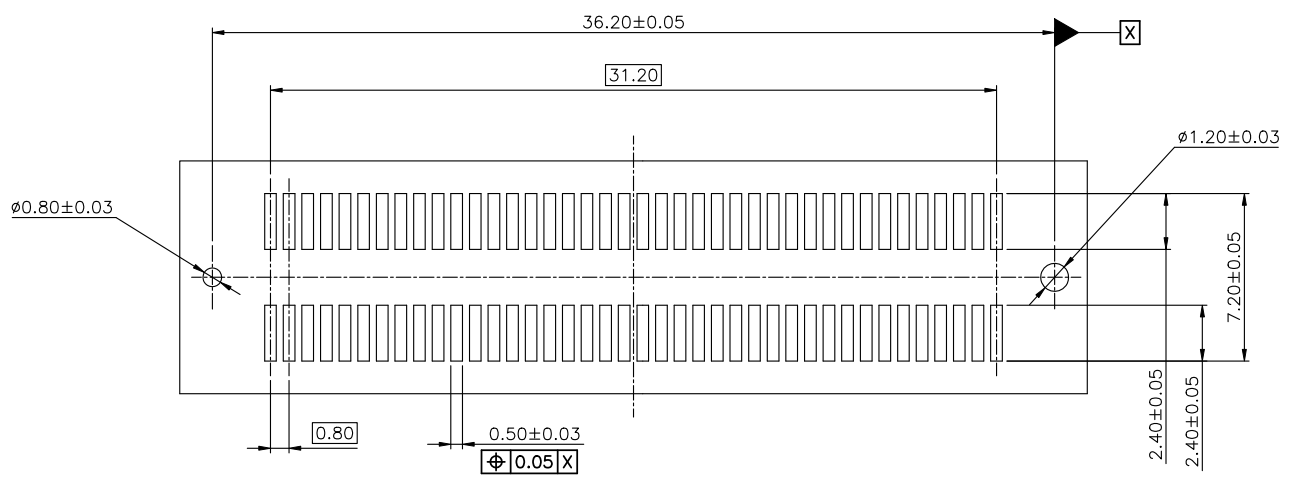

RECOMMENDED PCB LAYOUT(2:1)
 RECOMMENDED PCB LAYOUT TOLERANCE:±0.05mm

产品客户图 Customer Drw		GLGNET® 深圳市方向电子股份有限公司 SHEN ZHEN GLGNET ELECTRONICS CO., LTD.	
未注公差 TOLERANCE	.X ±0.20	比例 SCALE	1:1
UNLESS OTHERWISE SPECIFIED	.XX ±0.15	张数 SHEET	2/2
	.XXX ±0.08	单位 UNIT	mm
	X° ±3°	角法 PROJ.	角法
设计 DESIGN		版本 REV.	A3
品名 TITLE	BTB F-SV-1-2x40-P080-H117-00	核准 CHECKED	
料号 ITEM NO.	16007-00XXX1	核准 APPROVED	
图号 DWG NO.	GLG-WS-551		