

NO.	ECN NO.	DESCRIPTION	REV.	DRAW	DATE
1	-	INITIAL	1	YW PENG	2021/09/25
2	-	UPDATED	2	YW PENG	2021/11/13
3	-	UPDATED	3	YW PENG	2021/11/24
4	-	UPDATED	4	YW PENG	2022/01/06

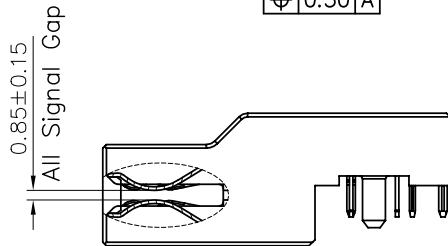
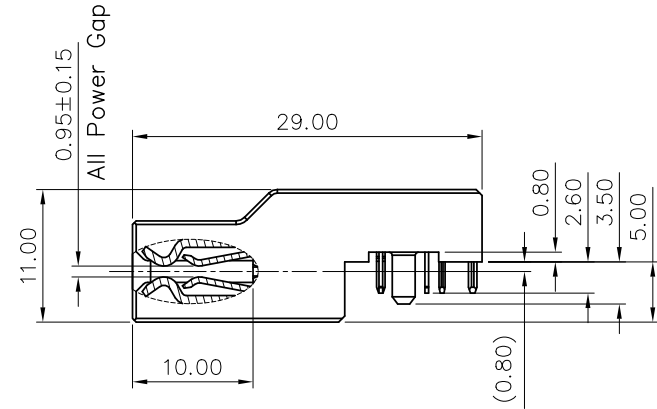
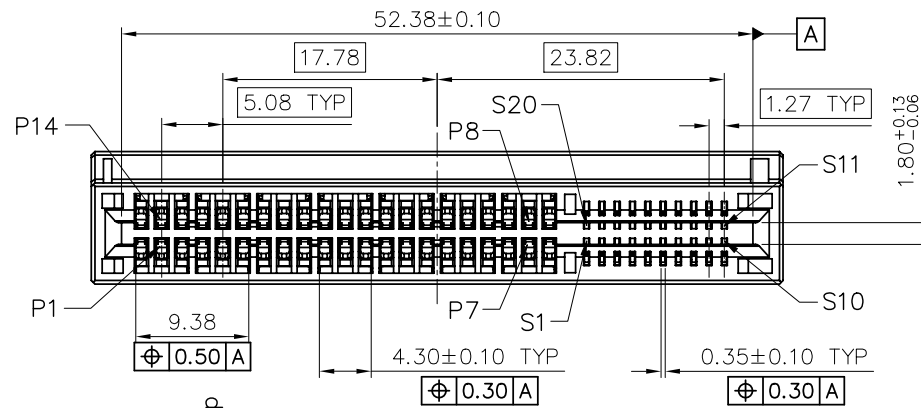
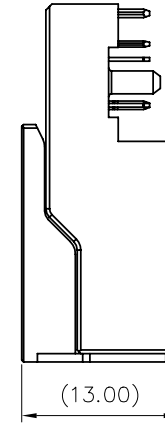
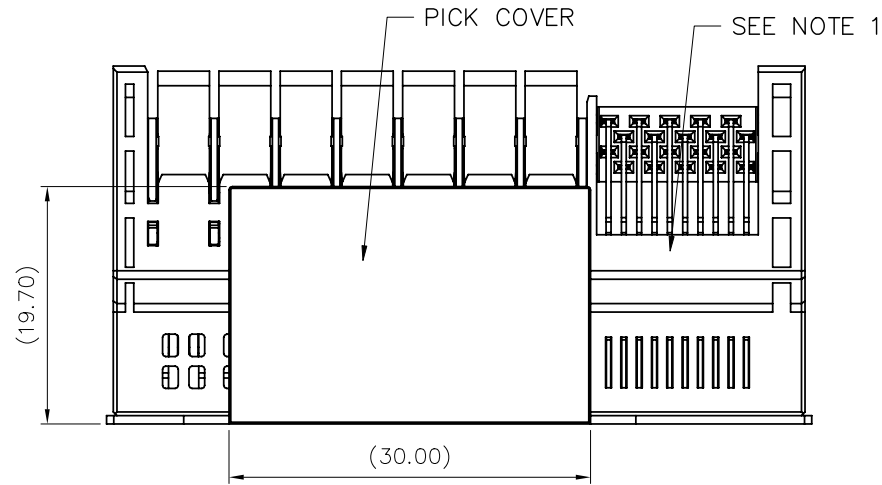

产品客户图 Customer Drw		GLGNET® 深圳市方向电子股份有限公司 SHEN ZHEN GLGNET ELECTRONICS CO.,LTD.					
未注公差 TOLERANCE UNLESS OTHERWISE SPECIFIED	.X ±0.35 .XX ±0.25 .XXX ±0.15 X° ±2°	设计 DESIGN	YW PENG	品名 TITLE	14P+20S RA STB RECEPTACLE		
比例 SCALE	1:1	角法 PROJ.	设计 CHECKED	YV PENG	料号 ITEM NO.	71B3-140020-A001	
张数 SHEET	1/3	纸张 SIZE	核准 APPROVE	HT ZHANG	图号 DWG NO.	GLG-71-037	
单位 UNIT	mm	版本 REV.	4				

8

7

6

5

4

3

2

1

NOTES:

- ① "GLGNET" AND DATE CODE TO BE MARKED ON THIS SURFACE.
2. MATERIALS:
HOUSING - GLASS FILLED HIGH TEMP THERMO PLASTIC, UL94V-0.
POWER CONTACTS - HIGH CONDUCTIVITY COPPER ALLOY.
SIGNAL CONTACTS - COPPER ALLOY.
3. CONTACT PLATING: NOBLE METAL PLATING ON FUNCTIONAL AREA FOR SIGNAL AND POWER CONTACTS.
- ④ MECHANICAL CONNECTOR KEEP OUT ZONE.
- ⑤ DATUM AND BASIC DIMENSIONS ESTABLISHED BY CUSTOMER.
- ⑥ PCB - ALL HOLE DIAMETERS ARE FINISHED HOLE SIZES.
7. PRODUCT SPECIFICATION: GLG-AR139.

NO.	ECN NO.	DESCRIPTION	REV.	DRAW	DATE
1	-	INITIAL	1	YW PENG	2021/09/25
2	-	UPDATED	2	YW PENG	2021/11/13
3	-	UPDATED	3	YW PENG	2021/11/24
4	-	UPDATED	4	YW PENG	2022/01/06

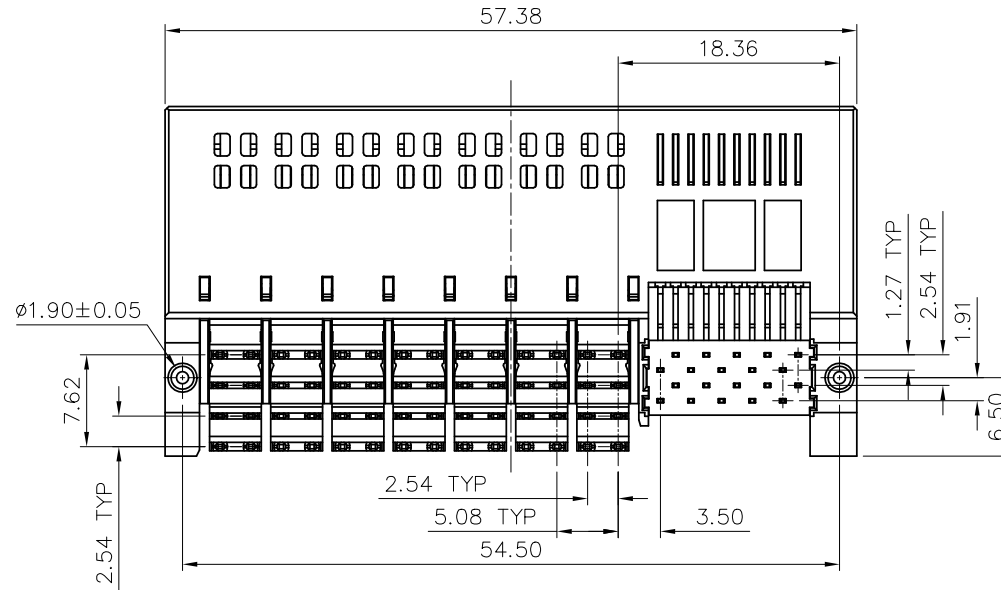

产品客户图 Customer Drw

未注公差 TOLERANCE	.X	± 0.35
UNLESS OTHERWISE SPECIFIED	.XX	± 0.25
	.XXX	± 0.15
	X°	$\pm 2^\circ$

GLGNET® 深圳市方向电子股份有限公司
SHEN ZHEN GLGNET ELECTRONICS CO.,LTD.

比例 SCALE	1:1	角法 PROJ.		设计 DESIGN	YW PENG	品名 TITLE	14P+20S RA STB RECEPTACLE
张数 SHEET	2/3	纸张 SIZE	A4	校对 CHECKED	YW PENG	料号 ITEM NO.	71B3-140020-A001
单位 UNIT	mm	版本 REV.	4	核准 APPROVE	HT ZHANG	图号 DWG NO.	GLG-71-037

8

7

6

5

4

3

2

1

NO.	ECN NO.	DESCRIPTION	REV.	DRAW	DATE
1	-	INITIAL	1	YW PENG	2021/09/25
2	-	UPDATED	2	YW PENG	2021/11/13
3	-	UPDATED	3	YW PENG	2021/11/24
4	-	UPDATED	4	YW PENG	2022/01/06

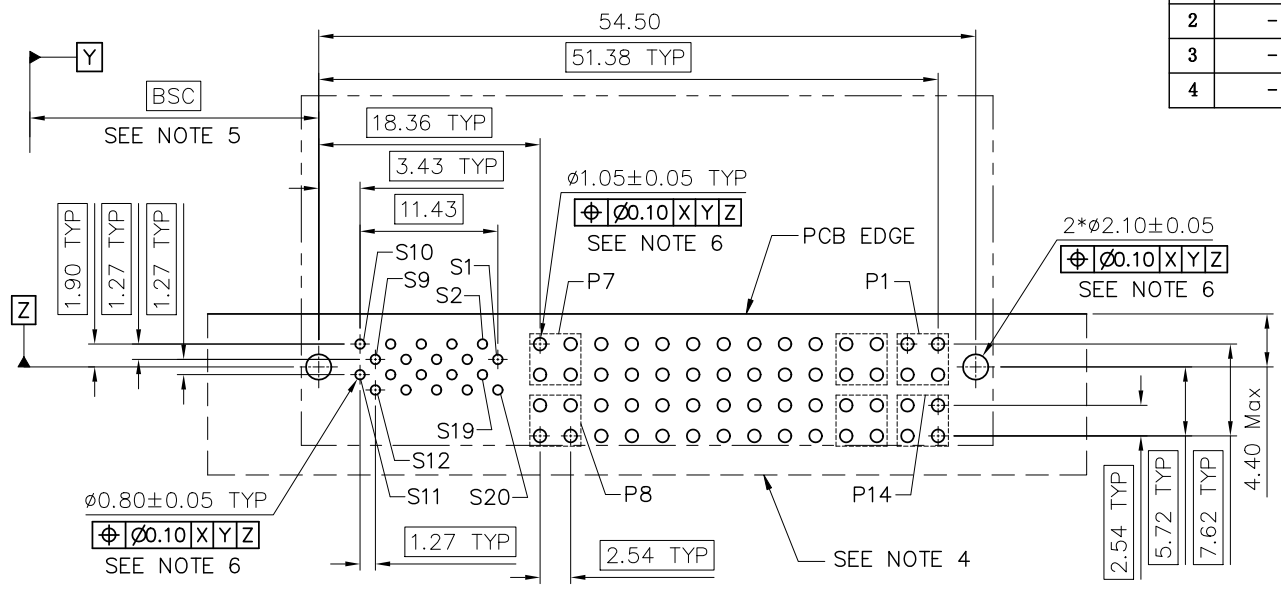

RECOMMENDED PCB LAYOUT
TOLERANCE: ±0.05mm

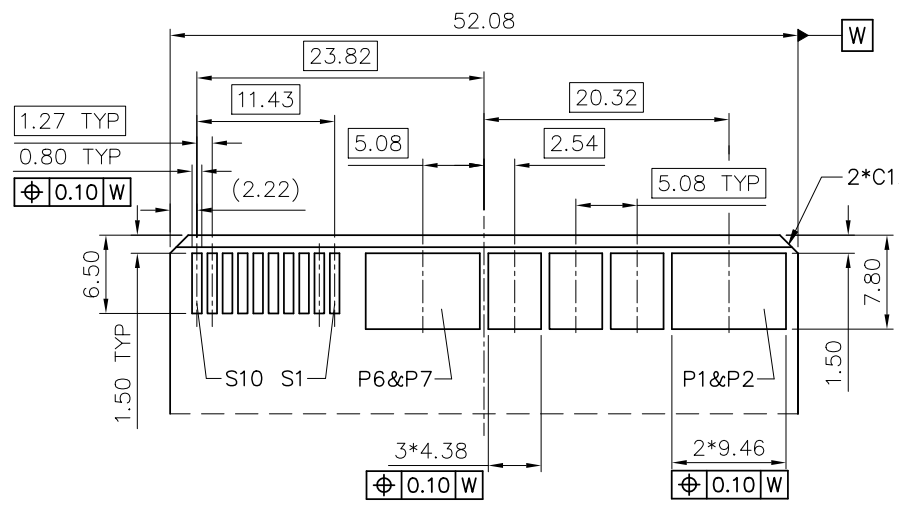

REFERENCE MATING CARD
TOLERANCE: ±0.05mm

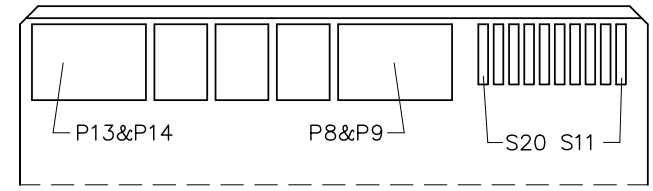
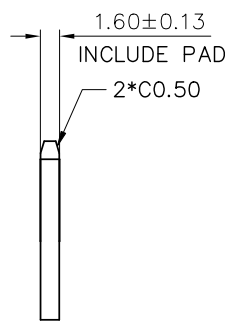

产品客户图 Customer Drw	
未注公差 TOLERANCE UNLESS OTHERWISE SPECIFIED	. X ±0.35 . XX ±0.25 . XXX ±0.15 X° ±2°
比例 SCALE	1:1
张数 SHEET	3/3
单位 UNIT	mm
角法 PROJ.	
纸张 SIZE	A4
版本 REV.	4

GLGNET 深圳市方向电子股份有限公司
SHEN ZHEN GLGNET ELECTRONICS CO.,LTD.

设计 DESIGN	品名 TITLE
YW PENG	14P+20S RA STB RECEPTACLE
校对 CHECKED	料号 ITEM NO.
YW PENG	71B3-140020-A001
核准 APPROVE	图号 DWG NO.
HT ZHANG	GLG-71-037