

NO.	ECN NO.	DESCRIPTION	REV.	DRAW	DATE
1	-	INITIAL	1	WU ZHANG	2022/06/01
2	-	UPDATED	2	LI JIN	2023/05/12
3	-	UPDATED	3	LI JIN	2023/05/20

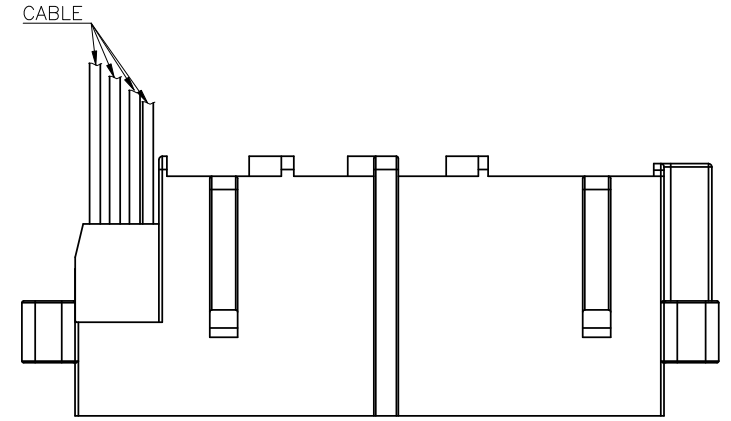
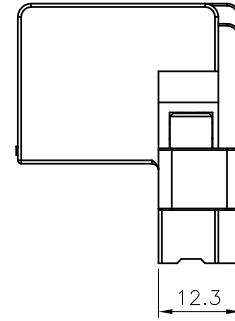
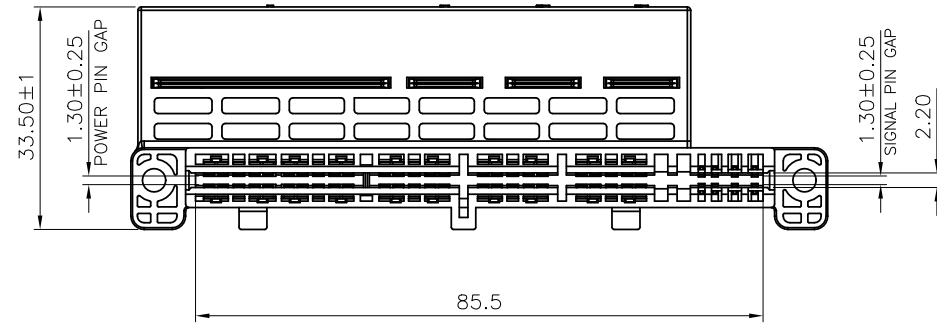
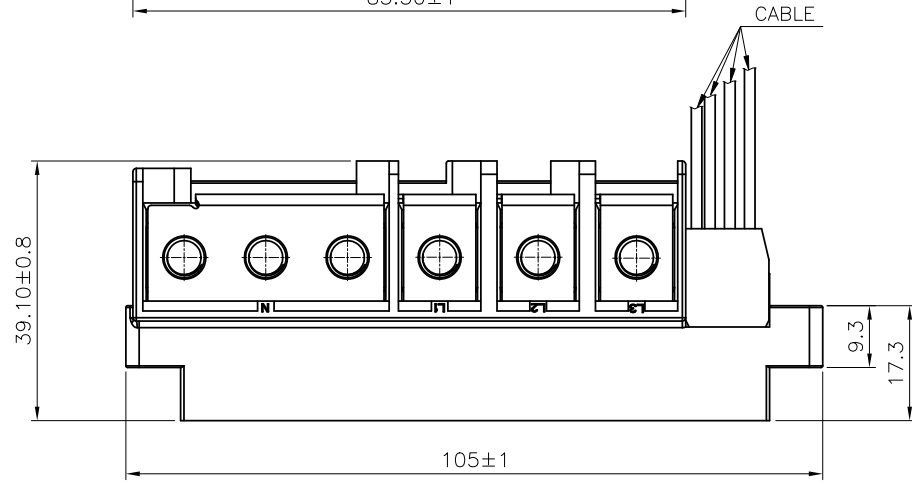
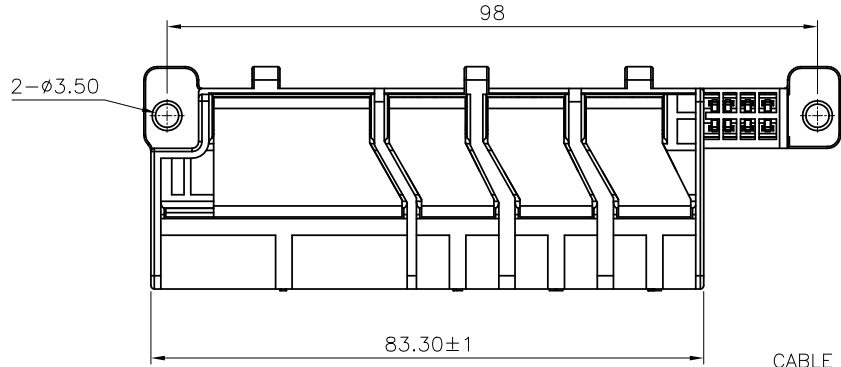

PRELIMINARY

产品客户图 Customer Drw		TOLERANCE		GLGNET® 深圳市方向电子股份有限公司			
未注公差	X	±0.50	GLGNET SHEN ZHEN GLGNET ELECTRONICS CO.,LTD.				
TOLERANCE	.X	±0.35					
UNLESS OTHERWISE SPECIFIED	.XX	±0.25					
	X°	±2°					
比例 SCALE	1:1	角法 PROJ.	设计 DESIGN	LI JIN	2023/05/12	品名 TITLE	160A金手指电源连接器
张数 SHEET	1/3	大小 SIZE	校对 CHECKED	YW PENG	2023/05/12	料号 ITEM NO.	170201-00111
单位 UNIT	mm	版本 REV.	核准 APPROVED	HT ZHANG	2023/05/12	图号 DWG NO.	170201

NO.	ECN NO.	DESCRIPTION	REV.	DRAW	DATE
1	-	INITIAL	1	WU ZHANG	2022/06/01
2	-	UPDATED	2	LI JIN	2023/05/12
3	-	UPDATED	3	LI JIN	2023/05/20

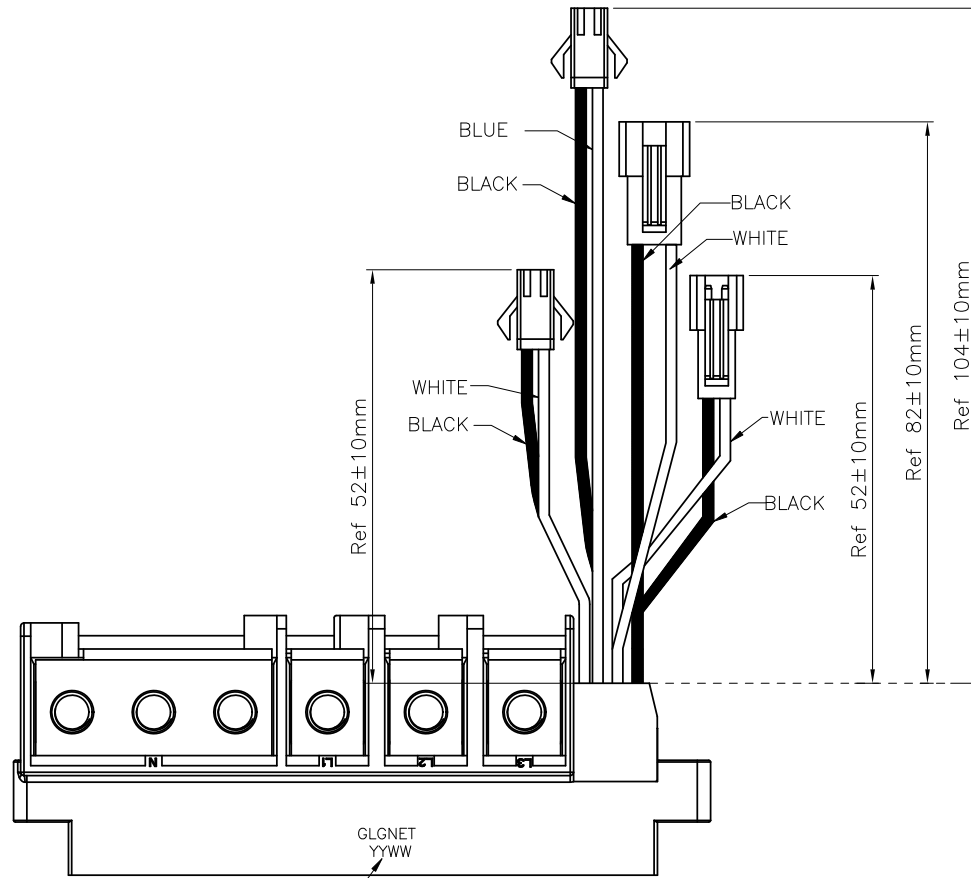

SEE NOTE 1

产品客户图 Customer Drw				GLGNET® 深圳市方向电子股份有限公司 SHEN ZHEN GLGNET ELECTRONICS CO.,LTD.				
未注公差 TOLERANCE UNLESS OTHERWISE SPECIFIED	X	±0.50	设计 DESIGN	LI JIN	2023/05/12	品名 TITLE	160A金手指电源连接器	
	.X	±0.35		校对 CHECKED	YW PENG	2023/05/12	料号 ITEM NO.	170201-00111
	.XX	±0.25		核准 APPROVED	HT ZHANG	2023/05/12	图号 DWG NO.	170201
	X°	±2°						
比例 SCALE	1:1	角法 PROJ.	第一角法					
张数 SHEET	2/3	大小 SIZE	A4					
单位 UNIT	mm	版本 REV.	3					

NO.	ECN NO.	DESCRIPTION	REV.	DRAW	DATE
1	-	INITIAL	1	WU ZHANG	2022/06/01
2	-	UPDATED	2	LI JIN	2023/05/12
3	-	UPDATED	3	LI JIN	2023/05/20

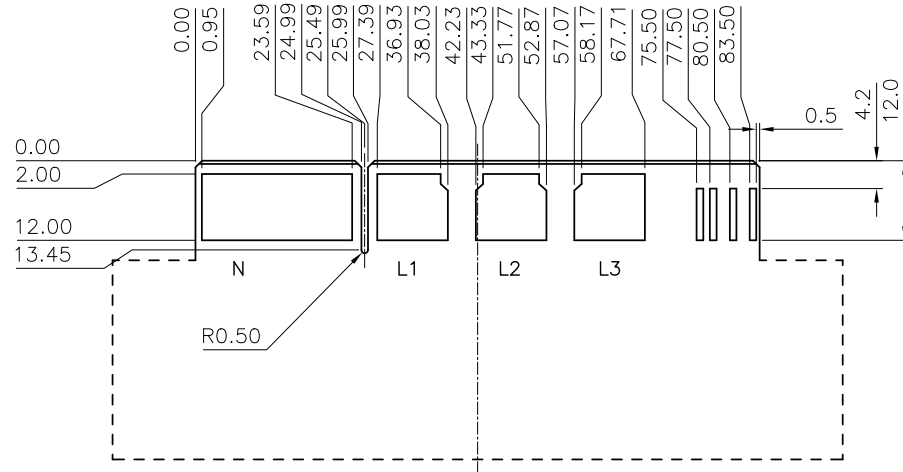

RECOMMENDED EDGE CARD FOOT PRINT (TOL:±0.05MM)
TOP SIDE VIEW

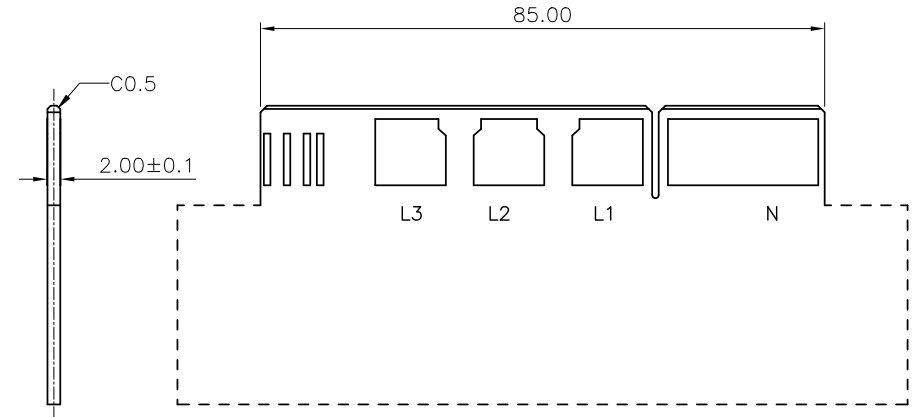

BOTTOM SIDE VIEW

NOTES :

- ① "GLGNET" AND DATE CODE(Y,YW,THE FIRST TWO ARE YEARS,AND THE LAST TWO ARE WEEKS) TO BE MARKED ON THIS SURFACE.
2. MATERIALS:
HOUSING - GLASS FILLED HIGH TEMP THERMO PLASTIC, UL94V-0.
POWER CONTACTS - HIGH CONDUCTIVITY COPPER ALLOY.
SIGNAL CONTACTS - COPPER ALLOY.
3. PLATING: 12u" GOLD OVER 50u" NICKEL UNDER PLATED.

产品客户图 Customer Drw				GLGNET® 深圳市方向电子股份有限公司 SHEN ZHEN GLGNET ELECTRONICS CO.,LTD.				
未注公差 TOLERANCE UNLESS OTHERWISE SPECIFIED	X	±0.50	设计 DESIGN	LI JIN	2023/05/12	品名 TITLE	160A金手指电源连接器	
	.X	±0.35		校对 CHECKED	YW PENG	2023/05/12	料号 ITEM NO.	170201-00111
	.XX	±0.25		核准 APPROVED	HT ZHANG	2023/05/12	图号 DWG NO.	170201
	X°	±2°						
比例 SCALE	1:1	角法 PROJ.	第一角法					
张数 SHEET	3/3	大小 SIZE	A4					
单位 UNIT	mm	版本 REV.	3					